



INSTRUCTION MANUAL

VHF TRANSCEIVER

IC-F310S

IC-F320S

UHF TRANSCEIVER

IC-F410S

IC-F420S

This device complies with Part 15 of the FCC Rules. Operation is subject to the condition that this device does not cause harmful interference.

**SmarTrunk II™
Compatible**

Icom Inc.

IMPORTANT

READ ALL INSTRUCTIONS carefully and completely before using the transceiver.

SAVE THIS INSTRUCTION MANUAL — This instruction manual contains important operating instructions for the **IC-F300S/F400S** series **VHF/UHF TRANSCEIVERS**.

EXPLICIT DEFINITIONS

The following explicit definitions apply to this manual.

WORD	DEFINITION
⚠ WARNING	Personal injury, fire hazard or electric shock may occur.
CAUTION	Equipment damage may occur.
NOTE	If disregarded, inconvenience only. No risk of personal injury, fire or electric shock.

 Versions of the IC-F310S/F320S/F410S/F420S which display "CE" on the serial number seal, comply with the essential requirements of the 89/336/EEC directive for Electromagnetic Compatibility.

CAUTIONS

⚠ WARNING! NEVER connect the transceiver to an AC outlet. This may pose a fire hazard or result in an electric shock.

NEVER connect the transceiver to a power source of more than 16 V DC such as a 24 V battery. This connection will ruin the transceiver.

NEVER cut the DC power cable between the DC plug and fuse holder. If an incorrect connection is made after cutting, the transceiver might be damaged.

NEVER place the transceiver where normal operation of the vehicle may be hindered or where it could cause bodily injury.

NEVER allow children to touch the transceiver.

NEVER expose the transceiver to rain, snow or any liquids.

USE supplied microphone only. Other microphones have different pin assignments and may damage the transceiver.

SmarTrunk II™ is a trademark of SmarTrunk Systems, Inc.

TABLE OF CONTENTS

IMPORTANT	i
EXPLICIT DEFINITIONS	i
CAUTIONS	i
TABLE OF CONTENTS	ii
1 PANEL DESCRIPTION	1–5
■ Front panel	1
■ Function LED	2
■ Programmable function keys	3
2 OPERATION	6–8
■ Turning power ON	6
■ Channel selection	6
■ Receiving and transmitting	7
◇ Transmitting notes	7
◇ DTMF transmission	8
◇ Scrambler function	8
■ User set mode	8
◇ Entering user set mode	8
3 CONNECTION AND MAINTENANCE	9–12
■ Rear panel and connection	9
■ Supplied accessories	10
■ Mounting the transceiver	11
■ Optional UT-96/UT-105/UT-109/UT-110 installation	11
■ Optional OPC-617 installation	12
■ Antenna	12
■ Fuse replacement	12
■ Cleaning	12
4 OPTIONAL SmarTrunk II™ OPERATION	13–15
■ SmarTrunk II™ and conventional modes	13
■ SmarTrunk II™ operation	13
5 OPTIONS	16

DO NOT use or place the transceiver in areas with temperatures below -30°C or above $+60^{\circ}\text{C}$ or, in areas subject to direct sunlight, such as the dashboard.

AVOID operating the transceiver without running the vehicle's engine. The vehicle's battery will quickly run out if the transceiver is in transmission while the vehicle's engine is OFF.

AVOID placing the transceiver in excessively dusty environments.

AVOID placing the transceiver against walls. This will obstruct heat dissipation.

AVOID the use of chemical agents such as benzine or alcohol when cleaning, as they damage the transceiver surfaces.

BE CAREFUL! The transceiver will become hot when operating continuously for long periods.

For U.S.A. only

CAUTION: Changes or modifications to this transceiver, not expressly approved by Icom Inc., could void your authority to operate this transceiver under FCC regulations.

1

PANEL DESCRIPTION

■ Front panel

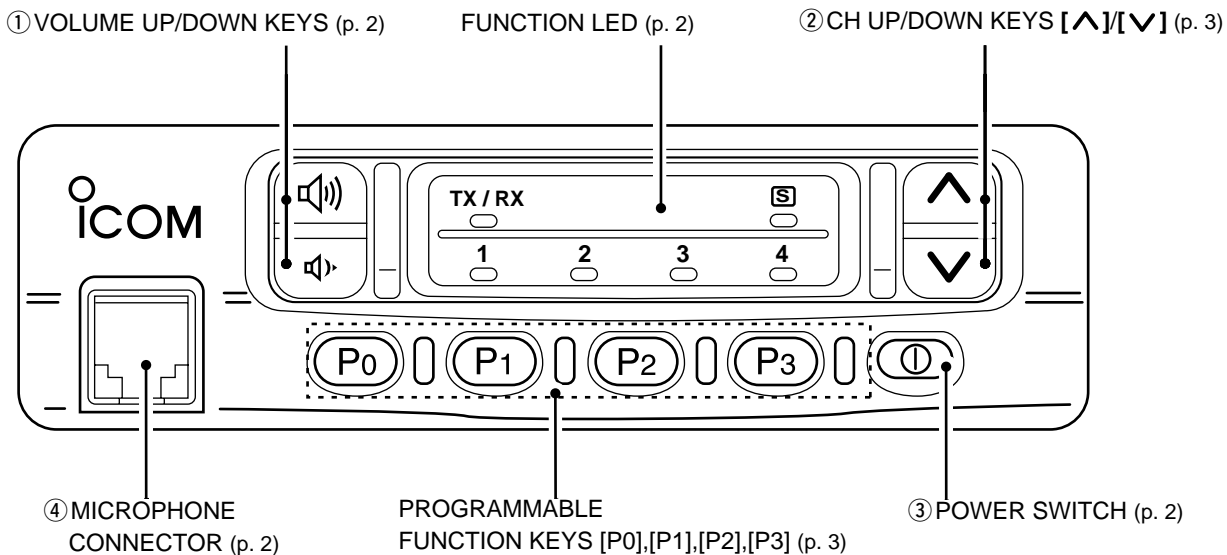

① **VOLUME UP/ DOWN KEYS**

- Push to adjust the audio output level.
- Minimum audio level is pre-programmed.

② **CH UP/DOWN [^][v] KEYS**

- Push to select the operating channel.
- Can be programmed for one of several functions by your dealer. (See p. 3)

③ **POWER SWITCH**

- Turns the power ON and OFF.
- The following functions are available at power ON as options:
 - Automatic scan start
 - Password prompt

④ **MICROPHONE CONNECTOR**

- Connect the supplied microphone or optional DTMF microphone for SmarTrunk II™ operation here.
- **NEVER** connect other microphones. The pin assignments may be different and the transceiver may be damaged.

MICROPHONE

- The supplied microphone has a PTT switch and a hanger hook.
- The following functions are available when the microphone is on or off hook:
 - Automatic scan start when hung up.
 - Automatic priority channel selection when off.
 - Sets to 'Inaudible' condition (mute condition) when hung up.
 - Sets to 'Audible' condition (unmute condition) when off.

■ **Function LED**

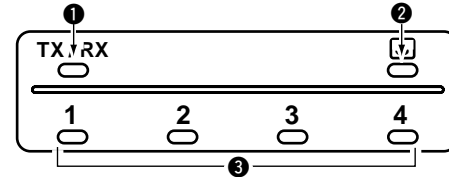

① **TRANSMIT/RECEIVE INDICATOR**

- Turns red: when transmitting.
- Turns green: when channel is busy.
- Green and red blink simultaneously: when the specified 5-tone call is received.
- Green and red blink alternately: cloning err.

② **SELECT INDICATOR**

- Lights while bank 2 or CH5 to CH8 is selected. (PMR model)
- Blinks slowly: talk around. (See p. 4)
- Blinks quickly: enter password.

③ **CHANNEL INDICATORS**

- Indicate the operating channel.
- Blink when receiving a signal during scanning operation.
- All LEDs blink while entering the power ON password.

NOTE:

When all function LED's blink, check that the DC battery voltage is not too high.

1 PANEL DESCRIPTION

■ Programmable function keys

The following functions can be assigned to the programmable function keys [P0], [P1], [P2], [P3], [^] and [v].

Consult your Icom dealer or system operator for details concerning your transceivers programming.

In the following explanations, programmable function names are bracketed, the specific switch used to activate the function depends on programming.

ATT ATTENUATOR

Push and hold to turn the attenuator function ON.

Push to turn the attenuator function OFF.

 **NOTE:** The attenuator function protects desired signals from distorting when excessively strong signals, such as broadcast, pager signals, etc. are nearby.

BANK BANK KEY (PMR only)

Selects a bank (a group of 4 channels).

- When selecting 4CH×2Bank type, push one or more times to select a channel bank for conventional channels or SmarTrunk II™ channels.

BEEP BEEP

Push to turn the beep tones ON/OFF.

CALL CALL KEYS

Transmit a 5-tone call.

CAL A

- Call transmission is necessary before you call another station depending on your signaling system.

CAL B

- The [CAL A] and/or [CAL B] keys may be available when your system employs selective 'Individual/Group' calls. Ask your system operator which call is assigned to each key.

CH UP CH UP AND DOWN KEYS

- Select an operating channel.

CH DN

DTMF DTMF KEY

Push and hold this key to transmit a specified DTMF code.

EMER EMERGENCY KEY

Push and hold the key to transmit an emergency call.

- If you want to cancel the emergency call, push (or push and hold) the key again before transmitting the call.
- The emergency call is transmitted one time only or repeatedly until receiving a control code depending on the pre-setting.

LITE LIGHT

ON → OFF → AUTO

Push to select the keybacklight and LED condition.

ON : Turns ON the LEDlight continuously.

OFF : Turns OFF* the LEDlight.

AUTO :Turns ON/OFF depending on the ACC socket pin 1 voltage.

ON: Low (0 V) OFF: High (12 V)

* Even when turned OFF, the LED lights slightly.

CH 1 OPERATING CHANNEL KEYS

CH 2 Select an operating channel directly.

CH 3

CH 4

HIGH OUTPUT POWER SELECTION KEYS

LOW1 Select the transmit output power temporarily or permanently depending on the pre-setting.

LOW2 • Push and hold to select low power.

• Push to cancel low power.

• Ask your Dealer or System Operator for the output power level for each selection.

SCAN SCAN START/STOP KEY (default [P0])

Push this key to start scanning; and push again to stop.

 **NOTE:** Place the microphone on hook to start scanning.

 Take the microphone off hook to stop scanning.

PRI A PRIORITY CHANNEL KEYS (default [P1])

PRI B Select priority A or priority B channel with each push.

T A TALK AROUND KEY (default [P2])

Push and hold to turn the talk around function ON.

Push to turn the talk around function OFF.

- The talk around function equalizes the transmit frequency to the receive frequency for mobile-to-mobile communication.

MONI MONITOR KEY (default [P3])

Activates one of (or two of) the following functions on each channel independently:

- Push and hold the key to unmute the channel (audio is emitted; 'Audible' condition).
- Push to mute the channel.
- Push the key to toggle the mute and unmute conditions (toggles 'Audible' and 'Inaudible').
- Push the key to mute the channel (sets to 'Inaudible' only).
- Push the key to unmute the channel (sets to 'Audible' only).
- Push the key after the communication is finished to send a 'reset code'.

 **NOTE:** The unmute condition ('Audible' condition) may automatically return to the mute condition ('Inaudible' condition) after a specified period.

1 PANEL DESCRIPTION

GRP

TRUNKING GROUP SWITCH

Push to select the trunking group.

SCRM

VOICE SCRAMBLER SWITCH

- Push and hold to turn the voice scrambler function ON.
- Push to turn the voice scrambler function OFF.

NOTE:

- Optional UT-109 (#02) or UT-110 (#02) VOICE SCRAMBLER UNIT is required.
- IC-F320(420)S's with serial numbers above 50000 are compatible with voice scrambler units.
- Contact your dealer for details.

PRODUCT INFORMATION

- This IC-F310/320(F410/420)S's with serial numbers above 50000 are compatible with the optional UT-109/ UT-110 voice scrambler units.

UT-109: Non-rolling type. 32 code numbers are available.

UT-110: Rolling type. Provides higher communication security. 1020 (4 groups × 255) code numbers are available.

- This transceiver requires version #02 scrambler units, do not install version #01, as they are not compatible.





- UT-109 and UT-110 require some PC board modifications. Please refer to the additional installation manual.

Please contact your dealer for details.

(See pgs. 5, 8, 11, 18)

■ Turning power ON

- ① Push [①] to turn the power ON.
- ② If the transceiver is programmed for a start up passcode, input digit codes as directed by your System operator.
 - The keys in the diagram below can be used for password input:
The transceiver detects numbers in the same block as identical. Therefore “1234” and “6789” are the same.

KEY					
NUMBER	0 5	1 6	2 7	3 8	4 9

- ③ When all channel indicator LEDs still blink after inputting 4 digits, the input code number may be incorrect. Turn power off and start over in this case.

■ Channel selection

Several types are available, and the channel selection method may differ according to your system set up.

NON-BANK TYPE:

Push the [**^**]/[**v**] keys to select the desired operating channel, in sequence; or, push one of the [**CH 1**] to [**CH 4**] keys to select these channels directly.

Select indicator  LED lights when CH5 to CH8 is selected. (PMR 8CH model)

BANK-TYPE: (PMR)

Push [**BANK**] to select the desired bank number.

Select indicator  LED lights when bank 2 is selected.

AUTOMATIC SCAN TYPE:

Channel setting is not necessary for this type. When turning the power ON, the transceiver automatically starts scanning. Scanning stops when receiving a call or when taking the microphone off hook.

2 OPERATION

■ Receiving and transmitting

RECEIVING:

- ① Push [①] to turn the power ON.
- ② Push [^]/[v] to select a channel.
- ③ When receiving a call, adjust the volume [UP] or [DOWN] to a comfortable listening level.

TRANSMITTING:

- ④ Take the microphone off hook.
 - 5-tone mute may be released.
 - A priority channel may be selected automatically.
- ⑤ Wait for the channel to become clear.
 - The channel is busy when TX/RX LED turns green.
- ⑥ Push the [CALL] key when initiating a call from your side.
 - Coded audio may be heard from the transceiver.
 - This operation may not be necessary depending on your signaling system. Ask your system operator or dealer.
- ⑦ While pushing and holding [PTT], speak into the microphone at your normal voice level.
- ⑧ Release [PTT] to receive.

 **IMPORTANT:** To maximize the readability of your signal: (1) pause briefly after pushing [PTT], (2) hold the transceiver 15 to 20 cm from your mouth, then speak into the microphone at a normal voice level.

◇ Transmitting notes

• Transmit inhibit function

The transceiver has several lockout/inhibit functions which restrict transmission under the following conditions:

- The channel is in mute condition.
- Channel is busy.
- No matched (or matched) CTCSS is received.
- The selected channel is a 'receive only' channel.

• Time-out timer

After continuous transmission for a pre-programmed period, the time-out timer is activated causing the transceiver to stop transmitting and automatically select receive.

• Penalty timer

Once the time-out timer is activated, transmission is further inhibited for a period determined by the penalty timer.

◇ DTMF transmission

If the transceiver has a [DTMF] key, the automatic DTMF transmission function is available.

◇ Scrambler function

A UT-109 (#02) or UT-110 (#02) optional voice scrambler unit provides high performance private communication between stations with the same scrambler codes.

- ① Push and hold [SCRM] to scrambler function ON.
- ② Push [SCRM] to turn the function OFF.

NOTE:

- UT-109 (#02) non-rolling type scrambler unit has 32 code numbers. UT-110 (#02) rolling type scrambler unit has 1020 (4 groups × 255) code numbers
 - IC-F320(420)S's with serial numbers above 50000 are compatible with voice scrambler units.
- Contact your dealer for details.

■ User set mode

User set mode is accessed at power ON and allows you to set seldom-changed settings. In this case you can “customize” transceiver operation to suit your preferences and operating style.

◇ Entering the user set mode

- ① While pushing and holding [▲] and [▼], push [①] to turn the user set mode ON, allowing you to set seldom-changed settings.
- ② [S] LED blinks quickly.

Available set mode functions

- Push [P 0] to set AF minimum level
- Push [P 1] to set beep ON or OFF
- Push [P 2] to set LED brightness
- Push [P 3] to set squelch level

- ③ Push [①] again to exit set mode.

3

CONNECTION AND MAINTENANCE

■ Rear panel and connection

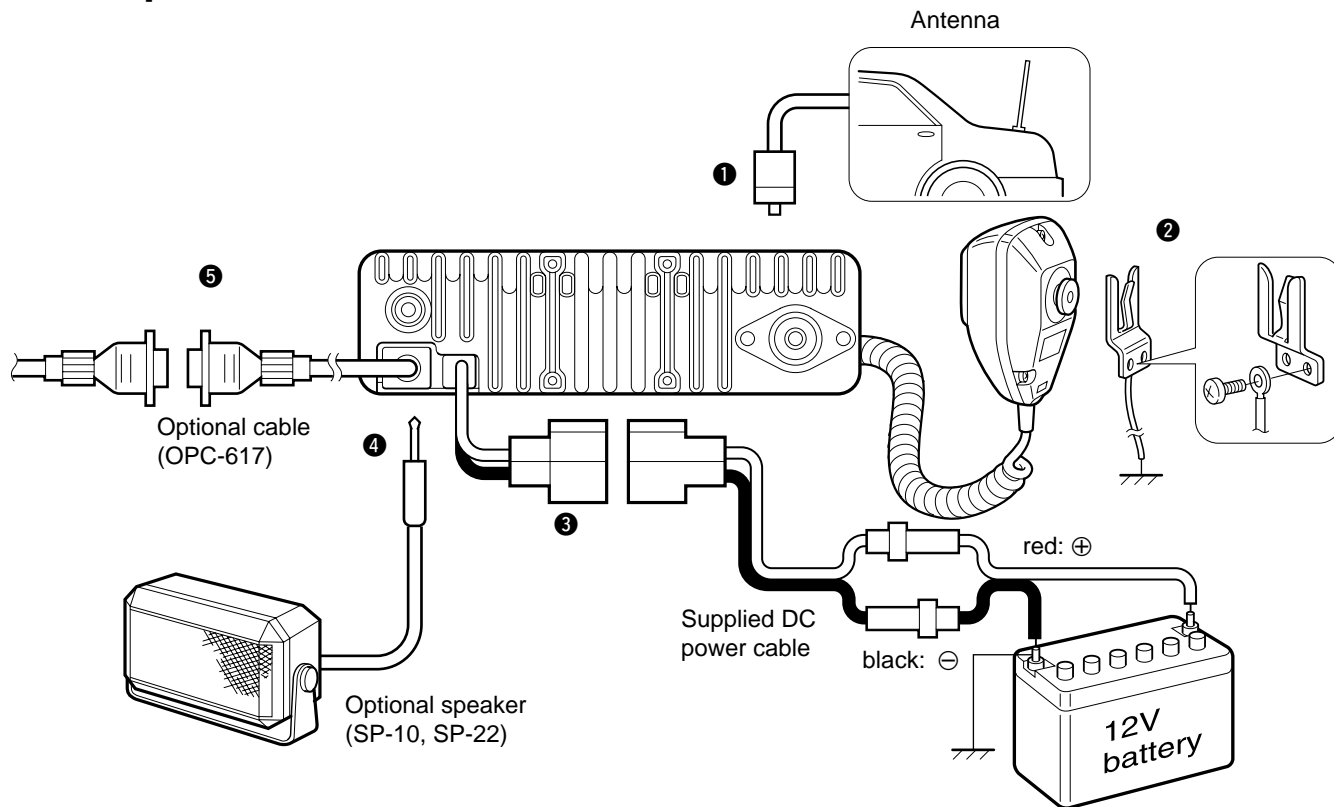

1 ANTENNA CONNECTOR

Connects to an antenna. Ask your dealer about antenna selection and placement. (See p. 12)

2 MICROPHONE HANGER

Connect the supplied microphone hanger to the vehicle's ground for on/off hook microphone functions. (See p. 2)

3 DC POWER RECEPTACLE

Connects to a 12 V DC battery. Pay attention to polarities. **NEVER** connect to a 24 V battery. This could damage the transceiver.

4 EXTERNAL SPEAKER JACK

Connect a 4–8 Ω external speaker, if desired.

5 OPTIONAL CABLE (OPC-617)

Connect an external modem unit, LCD backlight control, etc.

Supplied Accessories

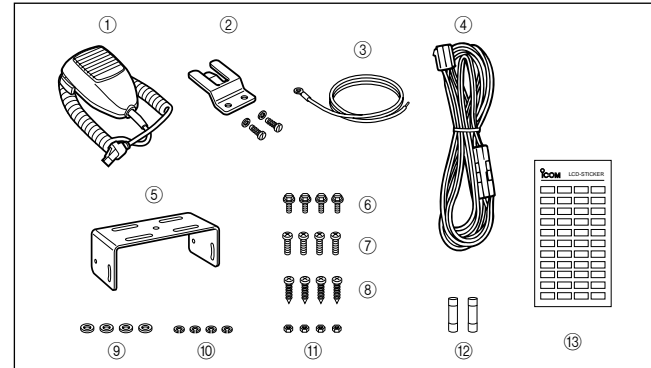

- | | |
|---|---|
| ① Microphone 1
(Some versions may not be supplied with a microphone) | ⑦ Mounting screws (M5×12) . 4 |
| ② Microphone hanger and screw set 1 set | ⑧ Self-tapping screws (M5×20) 4 |
| ③ Microphone hanger cable . 1 | ⑨ Flat washers 4 |
| ④ DC power cable1
IC-F310S/F410S: OPC-345
IC-F320S/F420S: OPC-346 | ⑩ Spring washers 4 |
| ⑤ Mounting bracket 1 | ⑪ Nuts 4 |
| ⑥ Bracket bolts 4 | ⑫ Fuses 2
IC-F310S/F410S: 15 A
IC-F320S/F420S: 20 A |
| | ⑬ Function name stickers*
1705 LCD SEAL(A)1 |

◇ *Function name stickers

There are no names on the programmable function keys since the needed functions can be assigned to these keys. Attach the supplied function name stickers above the appropriate keys.

3 CONNECTION AND MAINTENANCE

■ Mounting the transceiver

The universal mounting bracket supplied with your transceiver allows overhead mounting. Please read the following instructions carefully.

- Mount the transceiver securely with the 4 supplied screws to a sturdy surface which can support more than 1.5 kg.

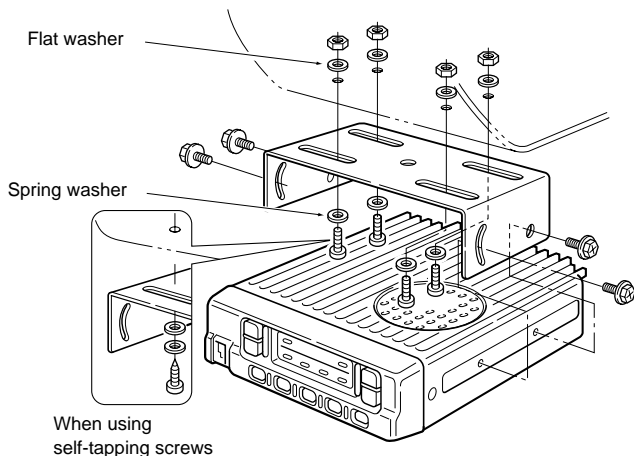

■ Optional UT-96/UT-105/UT-109 and UT-110 installation

The optional UT-96/UT-105/UT-109 and UT-110 units install as follows:

- ① Turn power OFF, then disconnect the DC power cable.
- ② Unscrew the 4 screws, then remove the bottom cover.
- ③ Install the unit as shown in the diagram below.
- ④ Replace the bottom cover and screws, then the DC power cable.

NOTE:

- UT-109 and UT-110 require some PC board modifications. Please refer to the additional installation manual.
- This transceiver requires #02 type scrambler units, do not install #01 types, as they are not compatible.

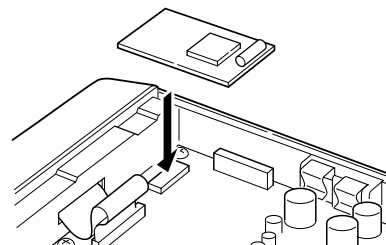

- The sponge supplied with the UT-105 is for the IC-F30/ F40 series transceivers only.

Optional OPC-617 installation

Install the OPC-617 as shown below.

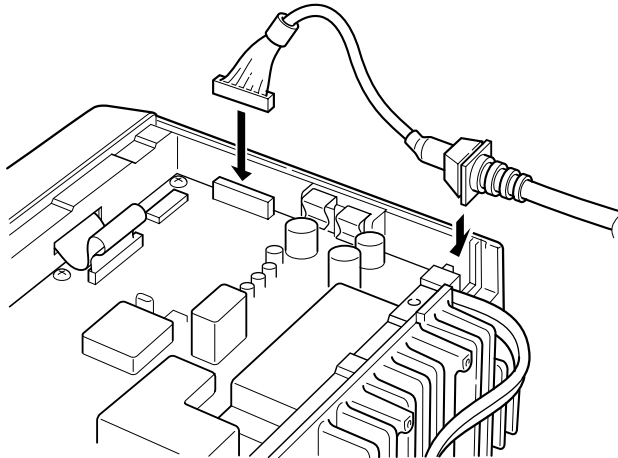

OPTIONAL CABLE PIN ASSIGNMENT

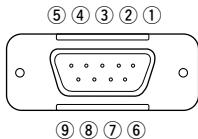

- | | |
|----------------------|------------------------|
| ① LED light cont. IN | ⑥ Horn drive cont. OUT |
| ② AF OUT | ⑦ AF GND |
| ③ Det. AF OUT | ⑧ Det. AF GND |
| ④ Mod. IN | ⑨ Mod. GND |
| ⑤ PTT control IN | |

Antenna

A key element in the performance of any communication system is an antenna. Ask your dealer about antennas and the best places to mount them.

Fuse replacement

Two fuses are installed in the supplied DC power cable. If a fuse blows or the transceiver stops functioning, track down the source of the problem, if possible, and replace the damaged fuse with a new, rated one.

□ Fuse rating IC-F310S/F410S: 15 A, IC-F320S/F420S: 20 A

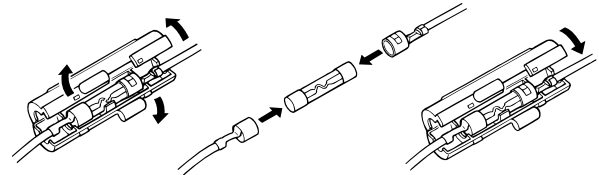

Cleaning

If the transceiver becomes dusty or dirty, wipe it clean with a dry, soft cloth.



AVOID the use of solvents such as benzene or alcohol, as they may damage transceiver surfaces.

■ SmarTrunk II™ and conventional modes

This transceiver is capable of SmarTrunk II™ functions.

The optional UT-105 allows communication in conventional channels or SmarTrunk II™ channels.

/// **NOTE:** Connect an optional HM-100T DTMF MICROPHONE. Contact your dealer for details.

■ SmarTrunk II™ operation

These features are enabled by a dealer or system operator and may not be available in your system. Contact your dealer for details.

◇ Placing a telephone call

Enter the phone number followed by [1], [*].

- A high-pitched beep indicates that the number is accepted.
- When the called party answers, push the [PTT] switch to talk, and release it to listen.

◇ Calling another local system subscriber

Enter the subscriber number followed by [3], [*].

- A high-pitched beep indicates that the number is accepted.
- You hear ringing, then two short beeps when the subscriber answers.
- If the other subscriber is on another call or out of range, you hear a fast busy signal and the call terminates automatically.

◇ Receiving a call

When you hear ringing, push [*] to answer.

- For a group call, you hear a short ring followed by two short beeps. You do not have to answer a group call to hear it over the air.

◇ Terminating a call

After completing a call, push [#] to disconnect (hang up).

 **IMPORTANT:** If one person in the conversation terminates a call, all participants will be cut off.

◇ Last number redial

Push [*], [*] to automatically redial the last number called.

- A high-pitched beep indicates that the number is accepted.

◇ Memory speed-dialing

To automatically dial a commonly used number from memory:

- Push [*] followed by the memory location (0–9).

◇ Turbo Speedial

To automatically dial a commonly used number with one push:

- Push one of the turbo Speedials ([A], [B], [C] or [D]).

◇ Programming memory speed dial

- ① Push and hold [*] until you hear a high-pitched beep.
- ② Enter the memory location (0–9, A, B, C, D), the telephone or subscriber number, then [1], [*] (or [3], [*] if for another system subscriber).
 - A high-pitched beep indicates successful programming.
 - Memories [A]–[D] are used for the Turbo Speedial.

◇ System busy indication

If all channels are busy, three low beeps sound after you initiate a call. Try the call again later.

◇ PTT dispatch operation

- ① Push [PTT] once (without dialing) to initiate a dispatch call.
- ② Begin talking after you hear three beeps (one short, high-pitched, two very-short, low-pitched).
- ③ Receiving a dispatch call is indicated by the same three-beep sequence.
 - It is not necessary to push [*] to answer a dispatch call.

◇ Emergency call

Push [0], [*] to initiate an emergency call.

- Contact your dealer for details.

4 OPTIONAL SmarTrunk II™ OPERATION

◇ **Clear channel alerting**

If all channels are busy, the transceiver automatically begins searching for an open channel and beeps every ten seconds. When two short beeps (low-pitched, then high-pitched) are heard, a channel is available. Push [*], [*] immediately to re-dial the last number.

 **NOTE:** For additional operating instructions, contact your dealer or system operator.

EXTERNAL SPEAKERS

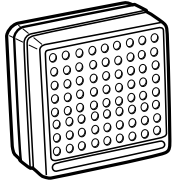

SP-5

Large speaker for good audio quality.

Input impedance: 4 Ω

Max. input power: 5 W

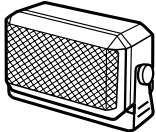

SP-10

Compact and easy-to-install.

Input impedance: 4 Ω

Max. input power: 5 W

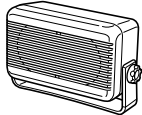

SP-22

Compact and easy-to-install

Input impedance: 4 Ω

Max. input power: 5 W

MICROPHONES



HM-100T

DTMF microphone.

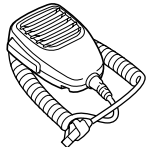

HM-100

Normal microphone.

OTHER UNITS

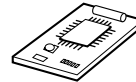

UT-96 5-TONE UNIT

Provides 2-tone/5-tone signaling.

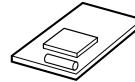

UT-105 SmarTrunk II™ Logic Board

Provides SmarTrunk II™ capabilities.

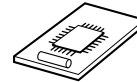

UT-109

UT-109/UT-110 VOICE SCRAMBLER UNIT

- UT-109: Non-rolling type (max. 32 codes)
- UT-110: Rolling type (max. 1020 codes)

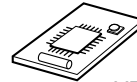

UT-110

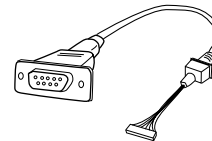

OPC-617 ACC CABLE

Allows you to connect to an external terminal.

Count on us!

A-5560D-1EX
Printed in Japan
© 1998 by Icom Inc.

Icom Inc.

6-9-16 Kamihigashi, Hirano-ku, Osaka 547-0002 Japan